

RS
500

Sails

RS
500

1.

Sail numbers should be supplied with each sail.



• Cut along dotted lines to form the correct sail numbers.

2.

Unroll your new sail. Start with the numbers on the Starboard side. The numbers go below the batten pocket as indicated in the drawing. Refer to these dimensions for correct placement before sticking the numbers to the sail. There may already be faint lines on the sail to show you where the numbers go.

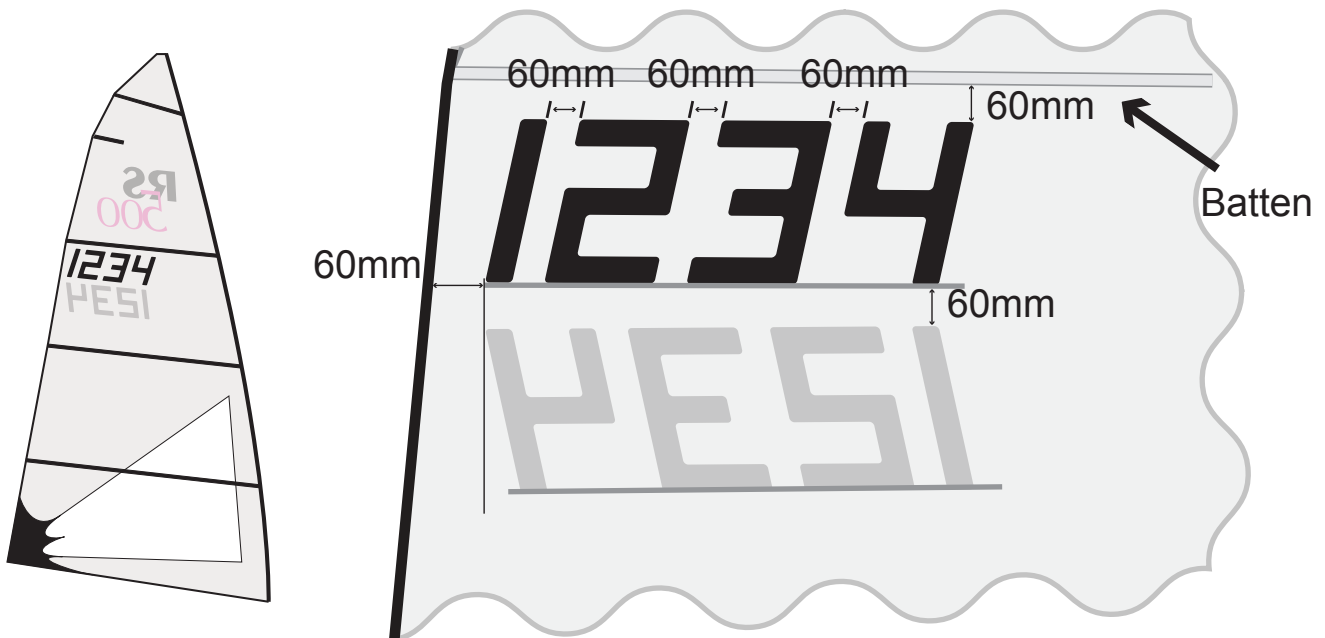

3.

The country letters on the Starboard side go 60mm below the batten pocket as indicated in the drawing. Country letters not supplied.

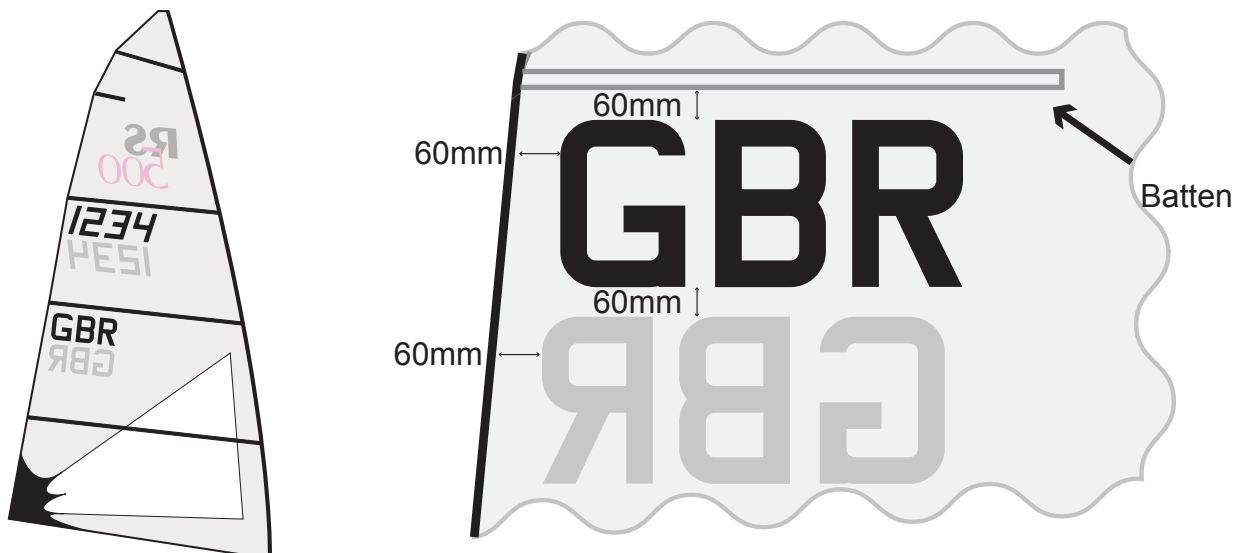

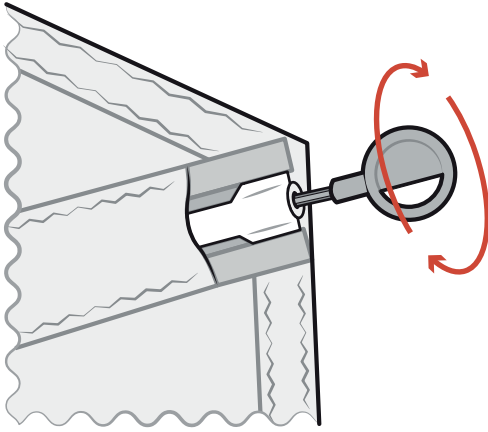

- Batten key should be on clew of sail.

Check the inboard ends of the battens are positively located in the inboard plastic end fitting. To tension, turn the key clockwise until the cloth becomes just tight. If it is over tightened you will have trouble tacking the head of the sail in light weather. Insufficient tension and the sail will set up too flat with wrinkles running down from the head.

SAIL CARE

Wash salt off sails after use and dry. Roll from the head. It is easier to fold the head in (as shown) so the top of the battens coincide before starting rolling. Store sail in its bag in dry conditions away from sunlight.

When using a new sail for the first time, try to avoid extreme conditions as high loads on new sailcloth can diminish the racing life of the sail.

If your sail is stained in any way, try to remove it using a light detergent and warm water. DO NOT attempt to launder the sail yourself. A sail can be temporarily repaired using a self-adhesive cloth tape, such as Dacron or Mylar. The sail should be returned to a sail maker for a professional repair. Check for wear and tear, especially around the batten pockets, on a regular basis.



Roll from 2nd batten.

